

PD8000/PD5000 Series Sliding & Pocket Door Locks



(Edition 3)

PD8000/PD5000 Series

**NEW RELEASE
SUMMER 2016**



TABLE OF CONTENTS

INOX PD8000/PD5000 Series Mortise Lock	Page 1
Description, Parts List, Dimensions	Page 4
INOX Adjustable Strikes	Page 5
How to Order	
PD8000/PD5000 Mortise Locks with Flush Pulls	Page 6
PD8000/PD5000 Mortise Locks with Surface Pulls	Page 7
INOX PD5000 Sliding & Pocket Door Lock	Page 8
Details, Specifications, Options	
Functions	
INOX PD8000 Sliding & Pocket Door Lock	Page 10
Details, Specifications, Options	
Mortise Cylinders and Keys	
Functions	
Flush Pull and Finish Options	Page 12
INOX Flush Pulls	
· FH27 Linear	Page 14
· FH29 Arc	Page 15
· FH31 Regal	Page 16
· FH32 Crown	Page 17
· FH22 Luna	Page 18
· FH23 Urban	Page 19
· Pocket and Edge Pulls	Page 20
Americans with Disabilities Act (ADA) Compliance	Page 21
ADA Pull Options	Page 22
Surface Pull Options	Page 22
Cylinder Collar, Thumb-turn, & Release Options	Page 25

Disclaimer: All information in this catalog has been deemed accurate as of the date of printing. We are continuously improving and expanding our line in an effort to offer our clients the finest quality products and services. Therefore, Unison Hardware, Inc., reserves the right to alter this information or correct printing errors at any time.

PD8000 & PD5000 Mortise Locks with Flush Pulls for Pocket Doors



PD8000 with FH27 Linear Flush Pull



PD5000 with FH29 Arc Flush Pull



PD5000 with FH22 Luna Flush Pull



PD8000 with FH23 Urban Flush Pull

PD8000 & PD5000 Mortise Locks

with Flush Pulls for Pocket Doors

**PD8000 with FH31 Regal Flush Pull****PD5000 with FH32 Crown Flush Pull**

PD8000 & PD5000 Mortise Locks with Surface Pulls for Sliding or Barn Doors



PD8000 with PHIX41714 ADA Pull



PD8000 with PHIX330.512.8 ADA Pull

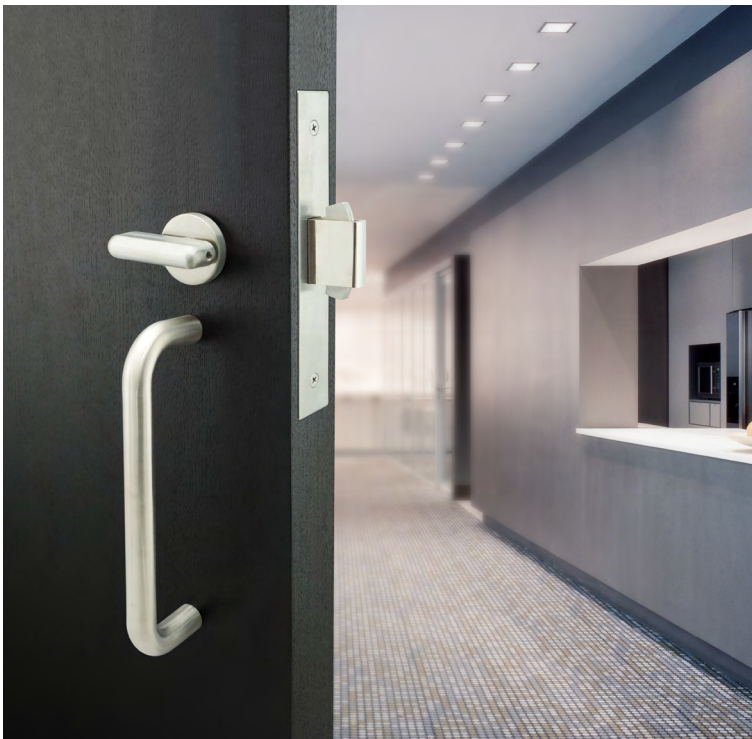

PD5000 with PHIX31108 ADA Pull



PD5000 with PHIX45714 ADA Pull

PD8000 Series Mortise Lock

PD84 : Lockcase with Deadbolt and Edge Pull

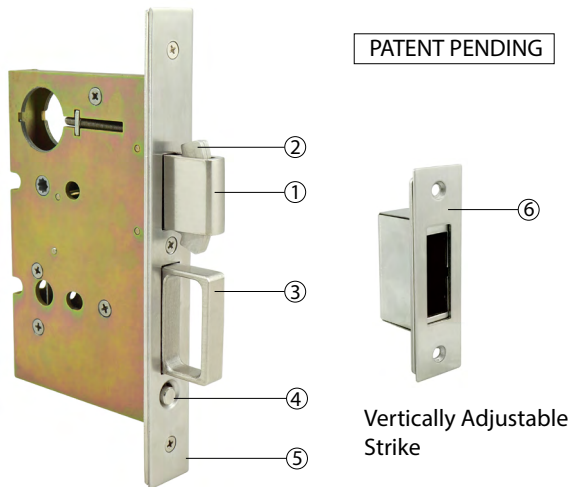

- 1) Brass deadbolt with 1" throw
- 2) Self-retracting hook with non-marring latch bolt
- 3) Spring-loaded edge pull with unique internal sound buffer
- 4) Solid brass push button
- 5) Stainless steel or brass faceplate, 2mm thick
- 6) Vertically adjustable strike (shown)
2D Adjustable Strike optional (PD-ADJ-2D-STRK)

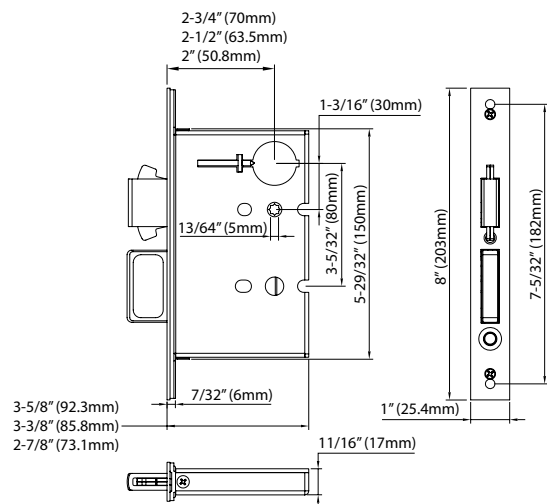

PD5000 Series Mortise Lock

PD53 : Lockcase with Deadbolt, NO Edge Pull

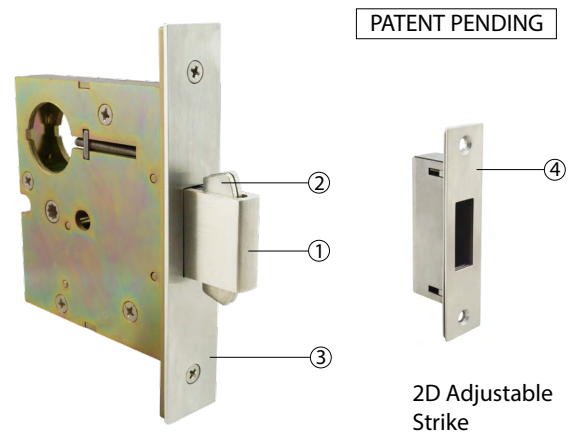

- 1) Brass deadbolt with 1" throw
- 2) Self-retracting hook with non-marring latch bolt
- 3) Stainless steel or brass faceplate, 2mm thick
- 4) Vertically-adjustable strike
2D Adjustable Strike optional (PD-ADJ-2D-STRK)
(2D Strike is shown)

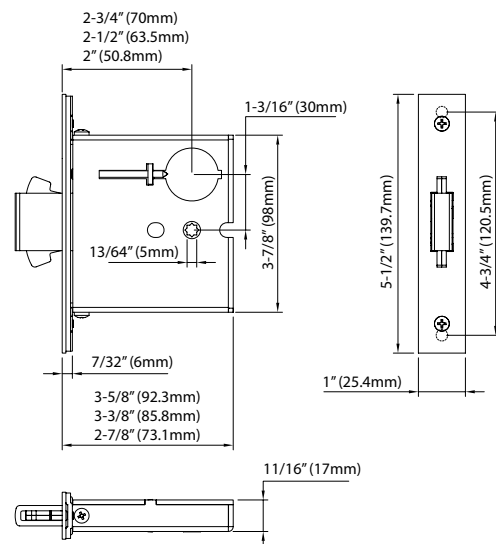

INOX[®] Vertically Adjustable and 2D Adjustable Strikes (Patent Pending)

The INOX[®] Vertically Adjustable Strike offers a distinctive, patent pending construction that allows adjustment of the dust box up to 1/4" vertically. The INOX 2D Adjustable Strike adds the ability for the installer to fine-tune the gap between door and frame with a simple adjustment of the built-in strike screws, ensuring a perfect fit.

- Can be adjusted before or after installation
- No modification to the door frame is necessary for adjustment
- Faceplate remains locked in place while the dust box is adjusted
- Once set, our unique slotted system holds the dust box and faceplate rigid for smooth door opening and closing
- With INOX[®] 2D Adjustable Strike, the strike plate screws pull the lock/door closer to the frame to minimize the gap, or widen the gap up to 3mm between door and frame to allow tolerances for weather stripping. See image A and inset.
- INOX[®] Adjustable and 2D Adjustable Strikes ensure perfect fit with easy installation

**Vertically Adjustable Strike
PD-ADJ-STRK**

Standard with INOX PD8000 & PD5000 Pocket & Sliding Door Locks

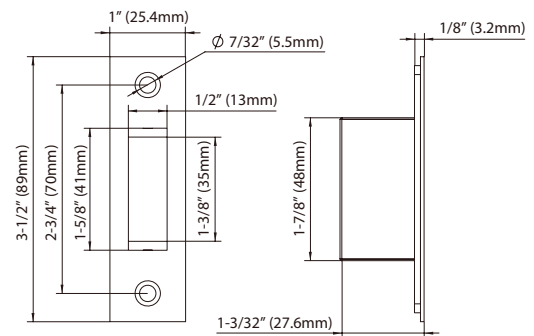
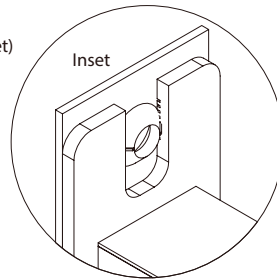
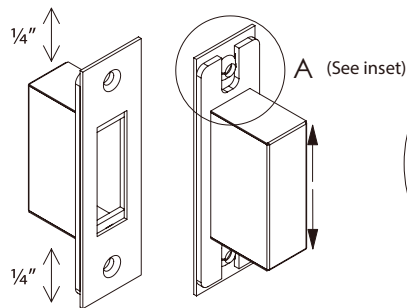
**2D Adjustable Strike
PD-ADJ-2D-STRK**

Special Order with INOX PD8000 & PD5000 Pocket & Sliding Door Locks

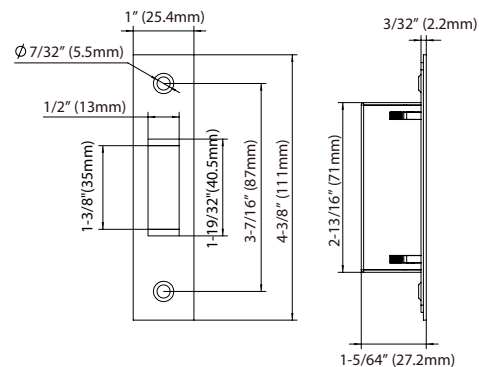
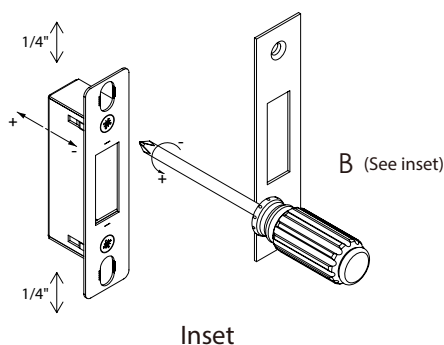

PD8000/PD5000 Mortise Locks with Flush Pulls for Pocket Door

How to Order

1. Specify/Order Flush Pull Locksets using complete codes as below:

Product Identification

FH27 PD8450 -234 -TT09 -32D

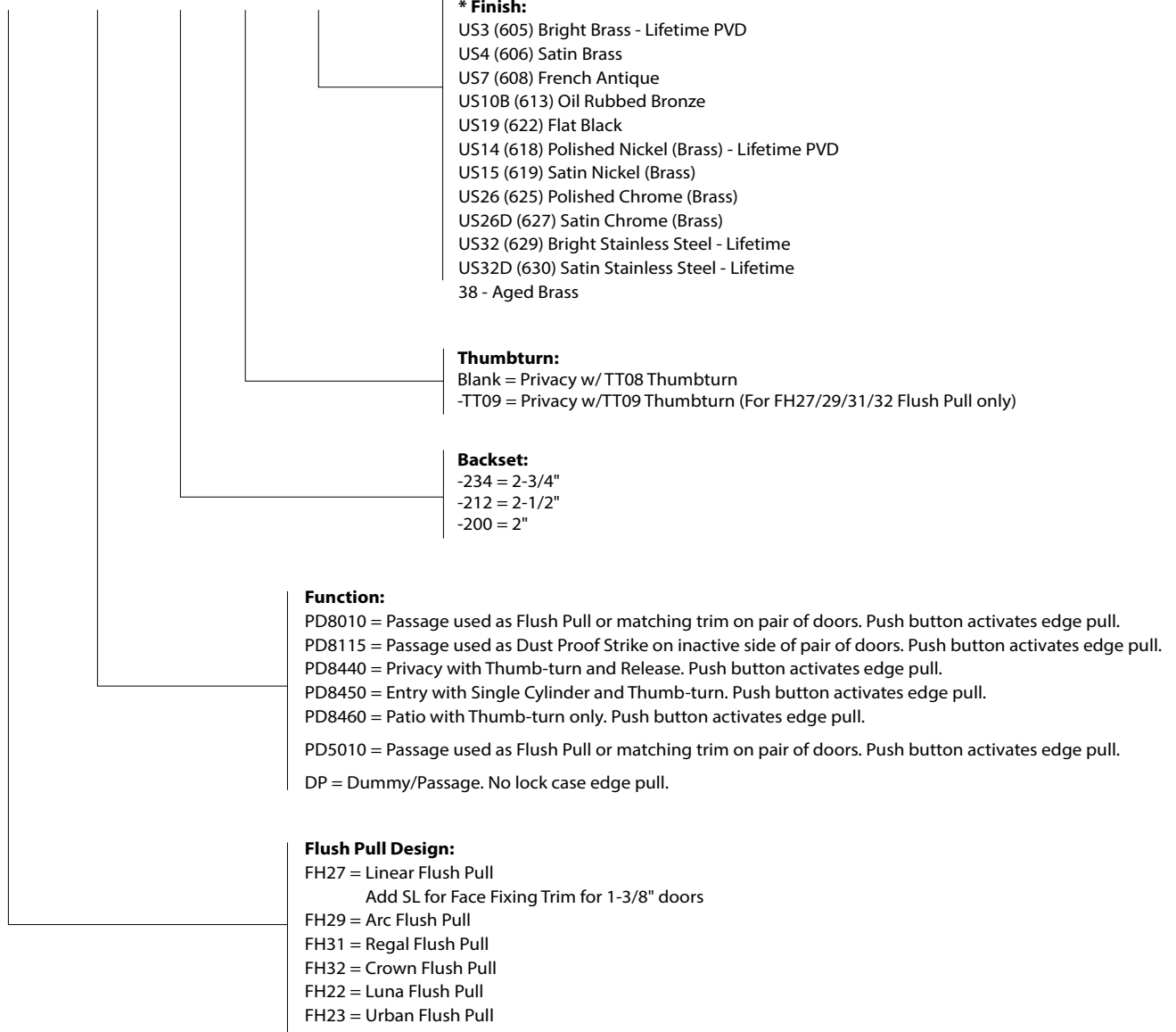

* See pp. 12-13 for Finish options, including in stock, special order, and lead time information.

PD8000/PD5000 Mortise Locks with Surface Pulls for Sliding/Barn Doors

How to Order

1. Specify/Order Pull Handle designs, sizes separately: See page 22 to 24 for ADA and non-ADA pulls available.
2. Specify/Order Sliding Door Locksets using complete codes as below:

Product Identification

GR04 PD8340 -234 -32D

Finish:

US32 (629) Satin Stainless Steel
 US32D (630) Bright Stainless Steel
 US19 (622) Flat Black

Backset:

-234 = 2-3/4"
 -212 = 2-1/2"
 -200 = 2"

Function:

PD8215 = Inactive - Passage with Built-in Dust Proof Strike for Inactive Pair Door. No Edge Pull.
 PD8340 = Privacy with Thumb-turn and Release. No edge pull.
 PD8350 = Entry with Single Cylinder and Thumb-turn. No edge pull.
 PD8360 = Patio with Thumb-turn only. No edge pull.
 PD5215 = Inactive - Passage with Built-in Dust Proof Strike for Inactive Pair Door. No edge pull.
 PD5340 = Privacy with Thumb-turn and release. No edge pull.
 PD5350 = Entry with Single Cylinder and Thumb-turn. No edge pull.
 PD5360 = Patio with Thumb-turn only. No edge pull.
 BTB = Dummy/Passage. No lock case or edge pull.

Thumb-turn and Release:

* Release included for privacy function.
 GR02 = (Dia. 1-13/16") Small Round Rose with TT02 Thumb-turn
 GR04 = (Dia. 1-13/16") Small Round Rose with TT04 Thumb-turn
 GR07 = (Dia. 1-13/16") Small Round Rose with TT07 Thumb-turn-ADA
 SR02 = (Dia. 1-13/16") Small Square Rose with TT02 Thumb-turn
 SR04 = (Dia. 1-13/16") Small Square Rose with TT04 Thumb-turn

PD5000 Sliding/Pocket Door Lock



Sliding/Barn Door



Pocket Door

Application

For residential or commercial application

Material

Lockcase: Heavy Gauge Steel
 Deadbolt and Edge Pull: Brass and Stainless Steel
 Faceplate and Strike: Stainless Steel or Brass
 Cylinder: Solid Brass

Finish

In Stock for Sliding/Barn Doors:

US32 (629) Bright Stainless Steel
 US32D (630) Satin Stainless Steel
 US19 (622) Flat Black (Brass)
 Special Orders available - see pages 12-13

For Pocket Doors:

See pages 12-13 for all Finish options

Specifications

Standard door thickness: 1-3/4" (45mm)
 1-3/8" (35mm) door thickness: See option on page 14
 Thick Door Kits available
 Handing: Non-Handed
 Thumbturn Spindle: 5x5mm square
 Deadbolt: 1" (25.4mm)
 Cylinder: Schlage C keyway 5 pin mortise cylinder with 2 keys (KD). Other keyways available upon request.
 Keying Services available. Order Separately.

Lock Options



PD50-234
 PD50-212
 PD50-200
 Edge Pull only



PD52-234
 PD52-212
 PD52-200
 Lockcase with built-in
 Dust Proof Strike for
 inactive pair of doors
 NO Edge Pull



PD53-234
 PD53-212
 PD53-200
 Lockcase with Deadbolt
 NO Edge Pull

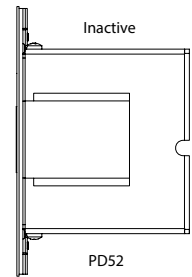
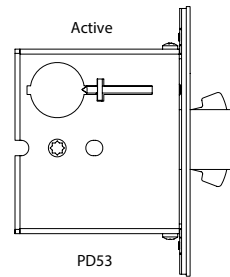

Functions

Sliding/Barn Doors

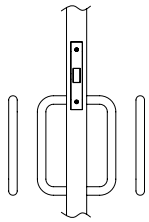
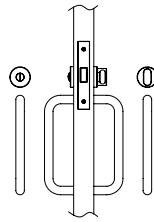
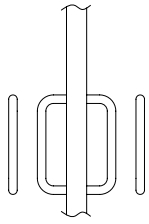
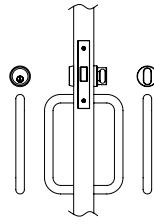
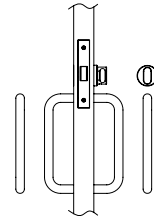
	<p>PD5215 Passage w/Lockcase as Dust Proof Strike Lockcase used as dust proof strike on pair of doors inactive side.</p>		<p>PD5340 Privacy w/Emergency Release Deadbolt operated by inside Thumbturn or outside emergency release coin turn.</p>
	<p>BTB Dummy/Passage without Lock Case</p>		<p>PD5350 Entry w/Single Cylinder Key outside or Thumbturn inside retracts deadbolt.</p>
			<p>PD5360 Patio Deadbolt operated by Thumbturn from inside only.</p>

Functions

Pocket Doors

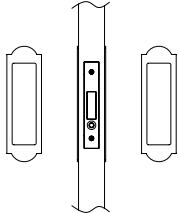
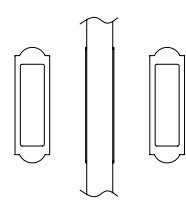
	<p>PD5010 Passage w/ Lockcase Used as flush pull or matching trim on pairs of doors. Edge finger pull operated by the push button.</p>		<p>DP Dummy/Passage without Lock Case</p>
---	---	--	--

PD8000 Sliding/Pocket Door Lock



Sliding/Barn Door



Pocket Door

Application

For residential or commercial application

Material

Lockcase: Heavy Gauge Steel
 Deadbolt and Edge Pull: Brass and Stainless Steel
 Faceplate and Strike: Stainless Steel or Brass
 Cylinder: Solid Brass

Finish

In Stock for Sliding/Barn Doors:

US32 (629) Bright Stainless Steel
 US32D (630) Satin Stainless Steel
 US19 (622) Flat Black (Brass)
 Special Orders available - see pages 12-13

For Pocket Doors:

See pages 12-13 for all Finish options

Specifications

Standard door thickness: 1-3/4" (45mm)
 1-3/8" (35mm) door thickness: See option on page 13
 Thick Door Kit available
 Backset: 2-3/4" (70mm), 2-1/2" (64mm), 2" (50mm)
 Handing: Non-Handed
 Thumbturn Spindle: 5x5mm square
 Deadbolt: 1" (25.4mm)
 Cylinder: Schlage C keyway 5 pin mortise cylinder with 2 keys (KD). Other keyways available upon request.
 Keying Services available. Order Separately.

Coming Soon

Emergency Egress Function Lock

Lock Options



PD80
 Lockcase with Edge Pull, no Deadbolt



PD81
 Lockcase with built-in Edge Pull and Dust Proof Strike for inactive pair door



PD82
 Lockcase with built-in Dust Proof Strike for an inactive pair door, NO Edge Pull



PD83
 Lockcase with Deadbolt, NO Edge Pull



PD84
 Lockcase with Deadbolt and Edge Pull

Active PD83
Inactive PD82

Mortise Cylinders and Keys

ϕ 1-23/64" (34.5mm)
 ϕ 1-9/64" (29mm)
 15/16" (24mm)
 1/8" (3mm)
 1/8" (3mm)

1/4" (6.3mm)
 33/64" (13.2mm)
 15/16" (23.9mm)
 11/64" (4.5mm)
 21/64" (8.4mm)
 39/64" (15.4mm)
 7/64" (2.8mm)

Clover Cam CAM01-SCL

Schlage C keyway, 5 pin, with clover cam; includes 2 keys, standard Keyed Different (KD). Other keyways and other keying services available upon request. All keyed functions use 15/16" (24mm) mortise cylinder for standard 1-3/4" (44mm) door. Thick Door Kit available on request.

Functions

Sliding / Barn Doors

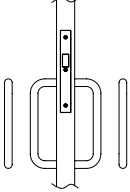
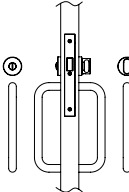
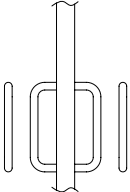
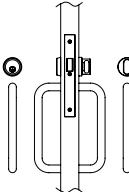
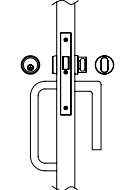
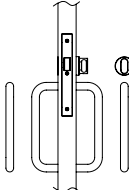
	<p>PD8215 Passage w/Lockcase as Dust Proof Strike Lockcase used as dust proof strike on pair of doors inactive side.</p>		<p>PD8340 Privacy w/Emergency Release Deadbolt operated by inside Thumbturn or outside emergency release coin turn.</p>
	<p>BTB Dummy/Passage without Lock Case</p>		<p>PD8350 Entry w/Single Cylinder Key outside or Thumbturn inside retracts deadbolt.</p>
	<p>PD8570 Entry w/Single Cylinder With Emergency Egress * NEW - COMING SOON *</p>		<p>PD8360 Patio Deadbolt operated by Thumbturn from inside only.</p>

Functions

Pocket Doors

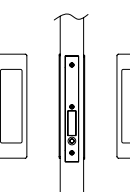
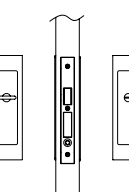
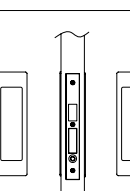
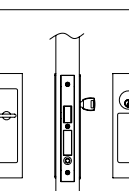
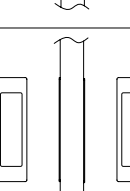
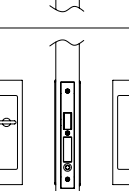
	<p>PD8010 Passage w/ Lockcase Used as flush pull or matching trim on pairs of doors. Edge finger pull operated by the push button.</p>		<p>PD8440 Privacy w/ Emergency Release Deadbolt operated by inside thumbturn or outside emergency release coin turn. Edge finger pull operated by the push button.</p>
	<p>PD8115 Passage w/ Lockcase as Dust Proof Strike Lockcase used as dust proof strike on pair of doors inactive side. Edge finger pull operated by the push button.</p>		<p>PD8450 Entry w/ Single Cylinder Key outside or Thumbturn inside retracts deadbolt with hook. Edge finger pull operated by the push button.</p>
	<p>DP Dummy/Passage without Lock Case</p>		<p>PD8460 Patio Deadbolt operated by Thumbturn from inside only. Edge finger pull operated by the push button.</p>

Flush Pull Options



Finish Options

TRIM DESIGN	DOOR THICKNESS		BRASS MATERIAL										STAINLESS STEEL MATERIAL	
	1-3/8" +	1-3/4" or more	Brass Tones				Dark Tones		Silver Tones					
		US3* (605)	US4 (606)	US7 (608)	38 (Aged Brass)	US10B (613)	US19 (622)	US14* (618)	US15 (619)	US26 (625)	US26D (626)	US32 (629)	US32D (630)	
FH27...	○	√	√	√	√	√	√	√	√	√	√	√	√	
FH27...SL**	√	Use FH27	○	√	○	○	√	√	○	√	○	√	○	
FH29...	○	√	√	√	√	○	√	√	√	○	√	√	√	
FH31...	○	√	√	√	√	√	√	√	√	○	√	√	√	
FH32...	○	√	√	√	√	√	√	√	√	○	√	√	√	
FH22...	N/A	√	√	√	√	√	√	√	√	○	√	√	√	
FH23...	N/A	√	√	√	√	√	√	√	√	○	√	√	√	

√ = In stock; standard lead time 1-2 weeks
 ○ = Special Order; standard lead time 8-12 weeks
 N/A = Not Available

Finish Key:

- US3 (605) Bright Brass - Lifetime PVD
- US4 (606) Satin Brass
- US7 (608) French Antique
- US10B (613) Oil Rubbed Bronze
- US19 (622) Flat Black (2-3 weeks lead time)
- US14 (618) Polished Nickel (Brass) - Lifetime PVD
- US15 (619) Satin Nickel (Brass)
- US26 (625) Polished Chrome (Brass)
- US26D (626) Satin Chrome (Brass)
- US32 (629) Bright Stainless Steel - Lifetime
- US32D (630) Satin Stainless Steel - Lifetime
- 38 - Aged Brass

* US3 (605) and US14 (618) are Lifetime PVD on Brass. See page 13 for more information and sample available colors.

** FH27...SL = Slim Trim for 1-3/8" Door with Face Fixing only. Not available as Keyed Entry Function (FH2703) or Privacy using TT08 Thumbturn (FH2782). Available in Passage/Dummy functions (FH2700) and Privacy /Patio functions with TT09 Thumbturn (FH2792) only.

Flush Pull Options

Stainless Steel

Stainless steel is a corrosion-resistant Lifetime metal, which makes it ideal for use on exterior doors that are subject to extreme weather conditions. INOX product has a stellar environmental track record with stainless steel manufacturing —our factories have state of the art processes that dramatically reduce carbon emissions, conserve energy, and recycle raw materials.

Our INOX line of stainless steel product brings out the beauty of the nickel content. Our hand polishing in the Satin Stainless Steel (US32D/630) finish exposes the elegant color and smooth texture of this rich metal and ensures a long-lasting finish compared to plating finishes.

Our mirror-like Bright Stainless Steel (US32/629) finish creates an elegant, modern look that complements and accentuates a variety of decors and architectural styles.



Satin Stainless Steel



Bright Stainless Steel

PVD - Physical Vapor Deposition

PVD is a process that produces a metal vapor deposited on electrically-conductive materials as a thin, highly adhered pure metal or alloy coating. A wide range of decorative PVD colors are available, including: Brass tones, Gold tones, Black to Grey, Silver tones (Nickel, Chrome), Copper and Bronze tones.

All of our PVD finishes are available in bright, satin or matte tones. Note that actual finish may differ from color shown.

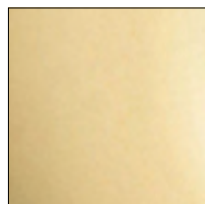
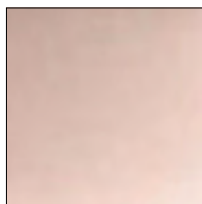
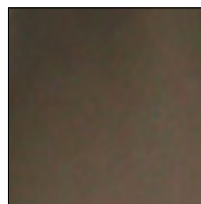
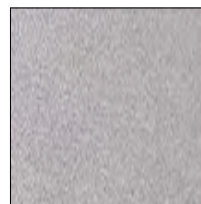
Brass Tone
PVDPolished Brass Tone
PVDLight Bronze Tone
PVDDark Bronze Tone
PVDNickel Tone
PVD

Ceramic Coating

Ceramic coating not only provides a rainbow of new color options, but offers effective abrasive-resistance qualities for areas with adverse weather conditions. In addition to our color variety, clear ceramic coating for added protection to Stainless Steel. **Never use abrasives to clean ceramic coating.**

Flat Black is in stock; inquire about other options and minimum order quantities.

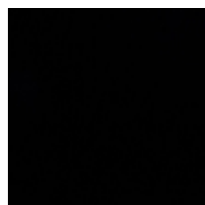
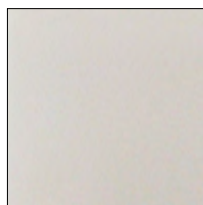
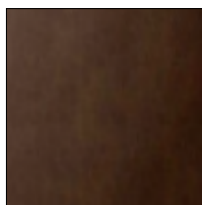
Flat Black
Allow 2-3 weeks lead timeWhite
Allow 4-6 weeks lead timeDark Brown
Allow 4-6 weeks lead time

Many other colors available!

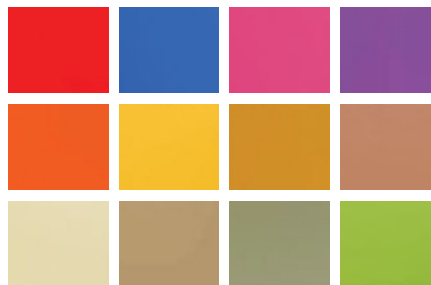

PVD and Ceramic Coating finishes other than Flat Black are special order; contact sales@unisonhardware.com for availability and lead times.

FH27 Linear Flush Pull

For PD8000/PD5000 Sliding & Pocket Door Locks



FH27 w/PD84



FH27 w/PD50

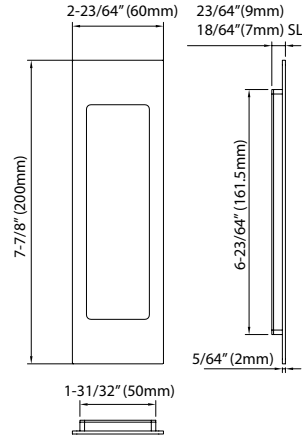

Specifications

Standard Door Thickness: 1-3/4" (45mm), Thick Door Kits available
 Slim Trim (SL) available for 1-3/8" (35mm) doors
 Hanging: Non-Handed
 Thumbturn Spindle: 5x5mm square
 Deadbolt: 1" (25.4mm)
 Cylinder: Schlage C keyway 5 pin mortise cylinder with 2 keys (KD).
 Other keys available upon request.
 Keying Services available. Order Separately.

Finish

See page 12~13 for Finish options.

Application

For residential or commercial application

Material

Stainless Steel/Brass

Options

Trim	Door Thickness	Fixing Type
FH27..	1-3/4" or greater	Discrete
FH27..SL*	1-3/8"	Face Fixing



FH27..SL*



FH2700
Flush Pull Only

Also Available:
FH2700SL



FH2703*
Flush Pull w/
Cylinder Hole

* Not available with SL



FH2782*
Flush Pull w/
TT08 Thumbturn



FH2792
Flush Pull w/
TT09 Thumbturn

Also Available:
FH2792SL



FH2704
Flush Pull w/
Thumbturn Release

Also Available:
FH2704SL

FH29 Arc Flush Pull

For PD8000/PD5000 Sliding & Pocket Door Locks



FH29 w/PD84

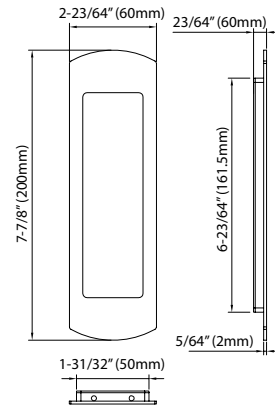

FH29 w/PD50

**Specifications**

Standard Door Thickness: 1-3/4" (45mm), Thick Door Kits available
 Handing: Non-Handed
 Thumbturn Spindle: 5x5mm square
 Deadbolt: 1" (25.4mm)
 Cylinder: Schlage C keyway 5 pin mortise cylinder with 2 keys (KD).
 Other keyways available upon request.
 Keying Services available. Order Separately.

Application

For residential, hospitality or commercial application

Material

Stainless Steel/Brass

Finish

See page 12~13 for Finish options.



FH2900
Flush Pull Only



FH2903
Flush Pull w/
Cylinder Hole



FH2982
Flush Pull
w/ TT08
Thumbturn



FH2992
Flush Pull
w/ TT09
Thumbturn



FH2904
Flush Pull w/
Thumbturn
Release

FH31 Regal Flush Pull

For PD8000/PD5000 Sliding & Pocket Door Locks



FH31 w/PD84



FH31 w/PD50

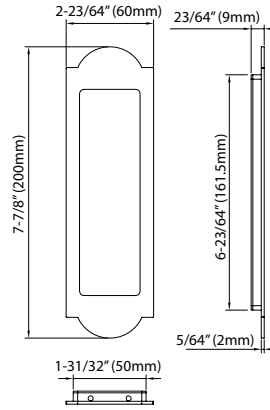

Specifications

Standard Door Thickness: 1-3/4" (45mm), Thick door kits available
 Handing: Non-Handed
 Thumbturn Spindle: 5x5mm square
 Deadbolt: 1" (25.4mm)
 Cylinder: Schlage C keyway 5 pin mortise cylinder with 2 keys (KD).
 Other keyways available upon request.
 Keying Services available. Order Separately.

Application

For residential, hospitality or commercial application

Material

Stainless Steel/Brass

Finish

See page 12~13 for Finish options.



FH32 Crown Flush Pull

For PD8000/PD5000 Sliding & Pocket Door Locks



FH32 w/PD84

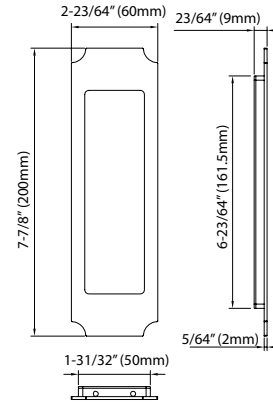

FH32 w/PD50

**Specifications**

Standard Door Thickness: 1-3/4" (45mm), Thick Door Kits available
 Handing: Non-Handed
 Thumbturn Spindle: 5x5mm square
 Deadbolt: 1" (25.4mm)
 Cylinder: Schlage C keyway 5 pin mortise cylinder with 2 keys (KD).
 Other keyways available upon request.
 Keying Services available. Order Separately.

Application

For residential, hospitality or commercial application

Material

Stainless Steel/Brass

Finish

See page 12~13 for Finish options.



FH3200
Flush Pull Only



FH3203
Flush Pull w/
Cylinder Hole



FH3282
Flush Pull
w/ TT08
Thumbturn



FH3292
Flush Pull
w/ TT09
Thumbturn



FH3204
Flush Pull w/
Thumbturn
Release

FH22 Luna Flush Pull

For PD8000/PD5000 Sliding & Pocket Door Locks



FH22 w/PD84



FH22 w/PD50

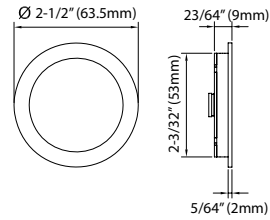

Specifications

Standard Door Thickness: 1-3/4" (45mm), Thick Door Kits available
 Handing: Non-Handed
 Thumbturn Spindle: 5x5mm square
 Deadbolt: 1" (25.4mm)
 Cylinder: Schlage C keyway 5 pin mortise cylinder with 2 keys (KD).
 Other keyways available upon request.
 Keying Services available. Order Separately.

Application

For residential, hospitality or commercial application

Material

Stainless Steel/Brass

Finish

See page 12~13 for Finish options.

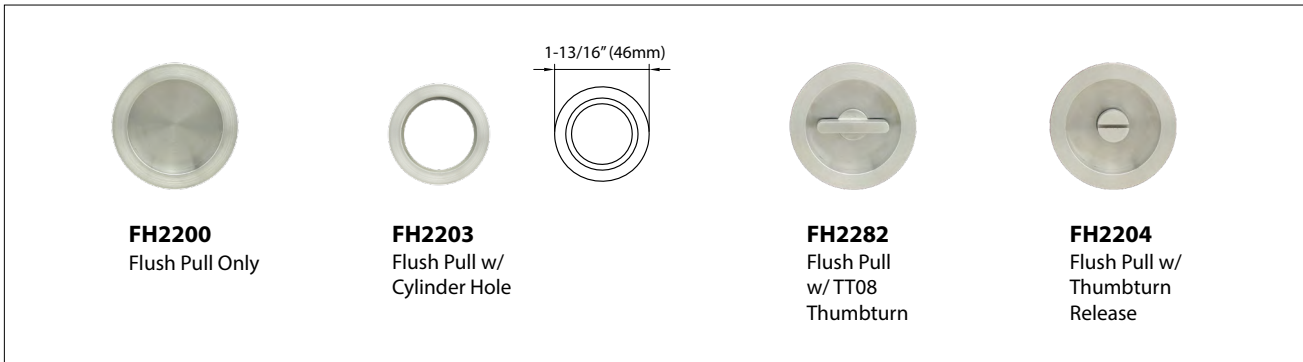

FH23 Urban Flush Pull

For PD8000/PD5000 Sliding & Pocket Door Locks



FH23 w/PD84

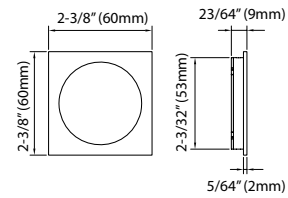

FH23 w/PD50

**Specifications**

Standard Door Thickness: 1-3/4" (45mm), Thick door kits available
 Handing: Non-Handed
 Thumbturn Spindle: 5x5mm square
 Deadbolt: 1" (25.4mm)
 Cylinder: Schlage C keyway 5 pin mortise cylinder with 2 keys (KD).
 Other keyways available upon request.
 Keying Services available. Order Separately.

Application

For residential, hospitality or commercial application

Material

Stainless Steel/Brass

Finish

See page 12~13 for Finish options.



FH2300
Flush Pull Only



FH2303
Flush Pull w/
Cylinder Hole

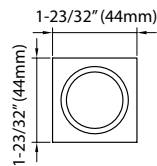

FH2382
Flush Pull w/
TT08 Thumbturn



FH2304
Flush Pull w/
Thumbturn
Release

Other Flush Pull Options Dummy/Passage Only)

Specifications

Stainless Steel, Concealed Fixing, Screws included
Only available for Dummy/Passage Functions
Finishes: US32, US32D, US10B, US4, US19

FHIX01
Flush Cup Pull

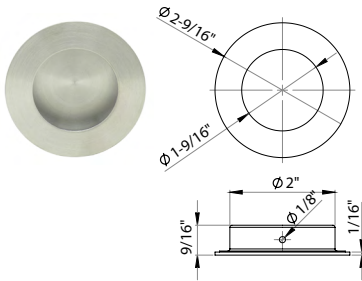

FHIX03
Flush Cup Pull

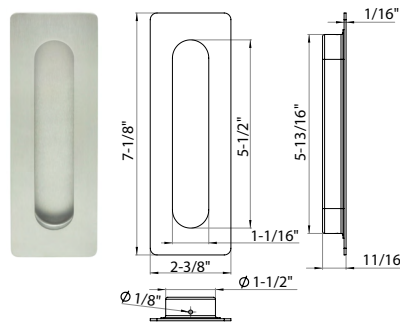

FHIX06
Flush Cup Pull

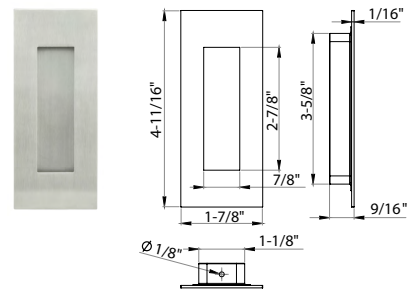

FHIX02
Flush Cup Pull

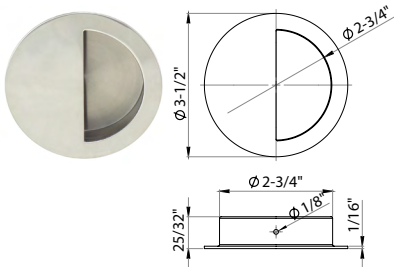

FHIX04
Flush Cup Pull

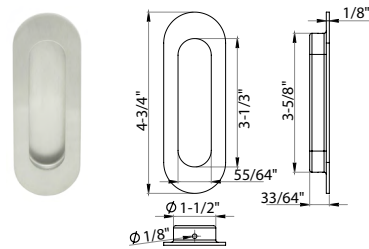

FHIX07
Flush Cup Pull

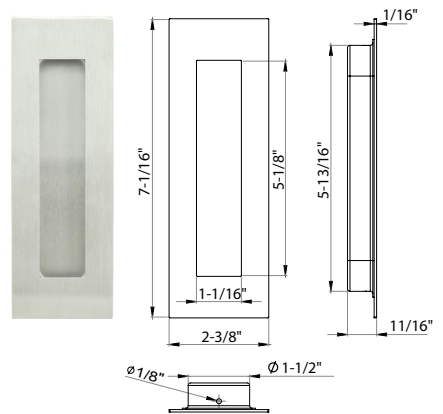

FHIX05
Flush Cup Pull

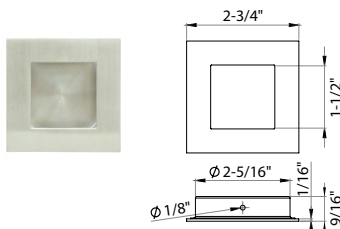

EPIX01
Edge Pull

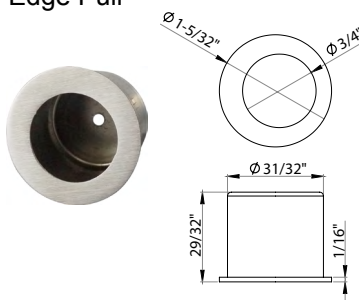

PD8000/PD5000 Mortise Locks with Surface Pulls for Sliding/Barn Doors Americans with Disabilities Act (ADA) Compliance

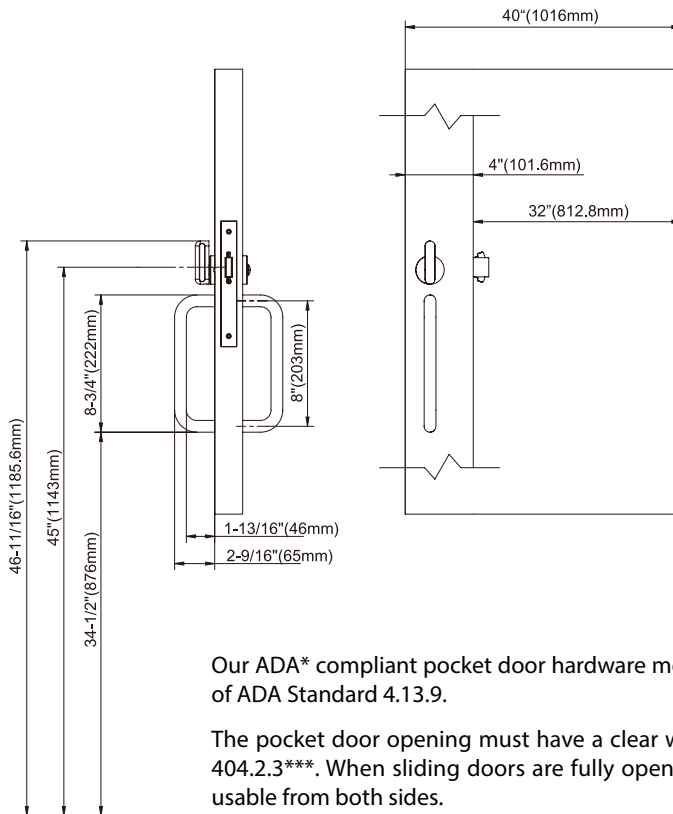

Our ADA* compliant pocket door hardware meets the "no grasp", "no pinch" requirements of ADA Standard 4.13.9.

The pocket door opening must have a clear width of 32" according to the ADA Standard 404.2.3***. When sliding doors are fully open, operating hardware shall be exposed and usable from both sides.

To accommodate these requirements, the total pocket door opening must be a MINIMUM of 40". The door must protrude a minimum of 4" from the jamb in order to install the ADA pocket door hardware on the door.

The hardware must be installed 34" above the finished floor or ground, giving the hardware a height of 47" (the maximum is 48") from the finished floor, meeting ADA Standard 404.2.7***.

*** Americans with Disabilities Act**

***** The ADA Standard 404.2.3 is from the Department of Justice ADA Publication dated September 15, 2012. Unison Hardware, Inc. recommends the end user double check all State and Federal standards for your particular project.**

ADA* Pull Options

Material: Stainless Steel

Stock Finishes: US32D (630) Satin Stainless Steel
 US32 (629) Bright Stainless Steel
 SP (split 32/32D) - PHIX41714 only
 US19 (622) Flat Black

* Americans with Disabilities Act

PHIX31108

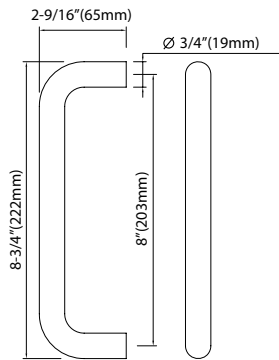
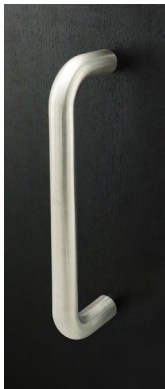

PHIX330.512.8

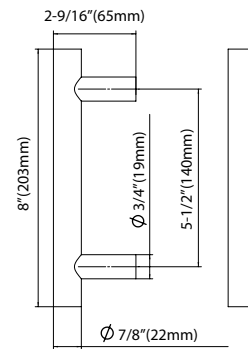

PHIX41714

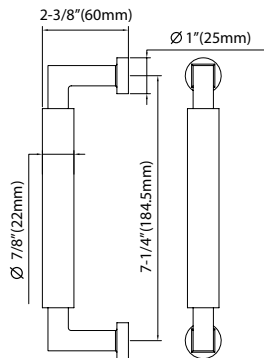

PHIX45714

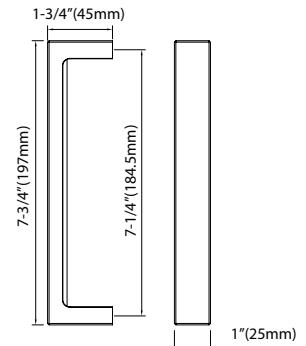

PHIX30108

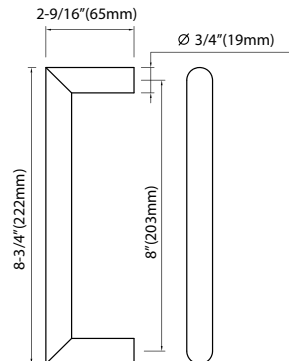
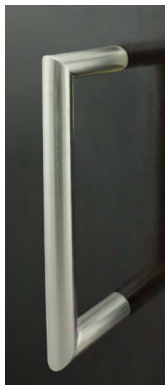

Surface Pull Options

Finishes: US32D (630) Satin Stainless Steel
 US32 (629) Bright Stainless Steel
 US19 (622) Flat Black

U-Shape Pull

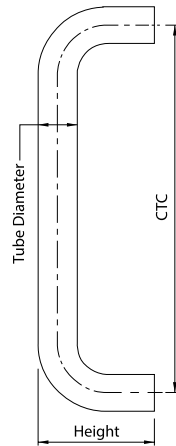

CTC	Overall	Projection	Item	Number
<i>Tube Diameter: Dia. 3/4"</i>				
6"	6-3/4"	2-3/4"	PHIX	31106
8"	8-3/4"	2-3/4"	PHIX	31108
10"	10-3/4"	2-3/4"	PHIX	31110
12"	12-3/4"	2-3/4"	PHIX	31112
<i>Tube Diameter: Dia. 1"</i>				
10"	11"	3"	PHIX	31210
12"	13"	3"	PHIX	31212
<i>Tube Diameter: Dia. 1-1/4"</i>				
12"	13-1/4"	3-1/4"	PHIX	31312
18"	19-1/4"	3-1/4"	PHIX	31318

D-Shape Pull

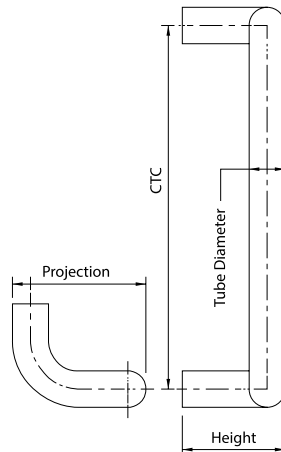

CTC	Overall	Projection	Offset	Item	Number
<i>Tube Diameter: Dia. 1"</i>					
10"	11"	3-1/4"	4-1/2"	PHIX	32210
12"	13"	3-1/4"	4-1/2"	PHIX	32212
<i>Tube Diameter: Dia. 1-1/4"</i>					
12"	13-1/4"	3-1/2"	4-3/4"	PHIX	32312
18"	19-1/4"	3-1/2"	4-3/4"	PHIX	32318

Functions:

- * Bolt-thru = 1 Single pull + 1 Bolt-thru fixing pack (Function Code: BT)
- * Back-to-back = 2 Single pulls + 1 Back-to-back fixing pack (Function Code: BTB)
- * On rosette = 1 Single pull + 1 On-Roses fixing pack (Function Code: OR) * Only available for U shape pull Dia. 3/4"

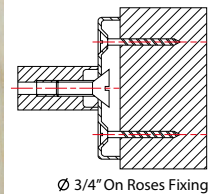
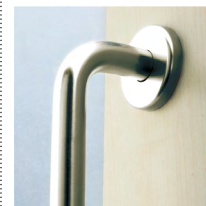
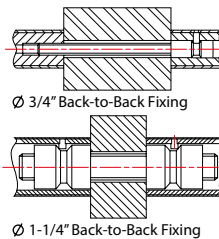
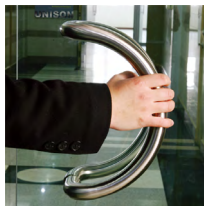
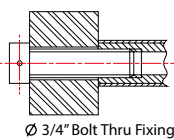

T-Shape Pull

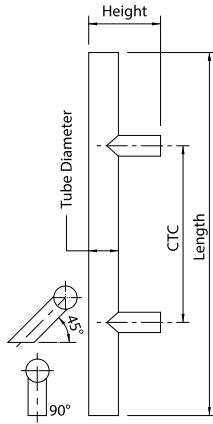

CTC	Overall	Projection	Degree	Item	Number
<i>Tube Diameter: Dia. 7/8"</i>					
5-1/2"	8"	2.5"	45°	PHIX	330.512.8
<i>Tube Diameter: Dia. 1-1/4"</i>					
10"	18"	3"	90°	PHIX	33310
12"	20"	3"	90°	PHIX	33312
18"	26"	3"	90°	PHIX	33318
48"	56"	3"	90°	PHIX	33348
60"	68"	3"	90°	PHIX	33360
10"	18"	3"	45°	PHIX	34310
12"	20"	3"	45°	PHIX	34312
18"	26"	3"	45°	PHIX	34318

C-Shape Pull

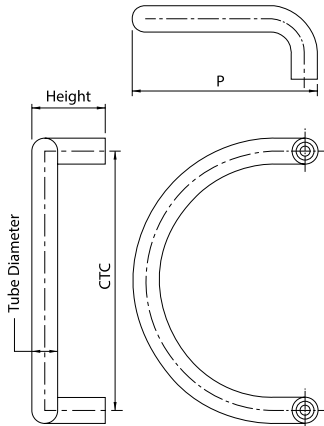

CTC	Overall	Projection	Offset	Item	Number
<i>Tube Diameter: Dia. 1-1/4"</i>					
12"	13-1/4"	3-3/8"	8"	PHIX	35312

V-Shape Pull

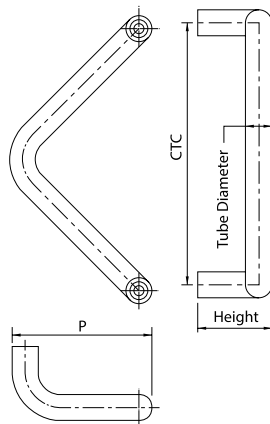

CTC	Overall	Projection	Offset	Item	Number
<i>Tube Diameter: Dia. 1-1/4"</i>					
12"	13-1/4"	3-1/4"	6"	PHIX	36312

Cylinder Collar, Thumbturn and Release Options

GR02

GR Small Rose.
TT02 Thumb-turn and release



GR Rose
T-Turn Side



GR Rose
Release Side

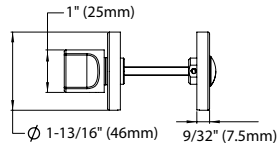

Product Illustration	Function	Item No.
	Mortise cylinder escutcheon	EC-R460COL
	Thumbturn on escutcheon	EC-R460TT02
	Thumbturn & Release	EC-R460TT02PVS

GR04

GR Small Rose.
TT04 Thumb-turn and release



GR Rose
T-Turn Side



GR Rose
Release Side

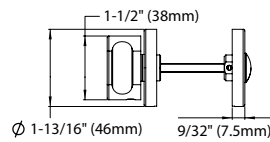

Product Illustration	Function	Item No.
	Mortise cylinder escutcheon	EC-R460COL
	Thumbturn on escutcheon	EC-R460TT02
	Thumbturn & Release	EC-R460TT02PVS

GR07

GR Small Rose.
TT04 Thumb-turn and release



GR Rose
T-Turn Side



GR Rose
Release Side

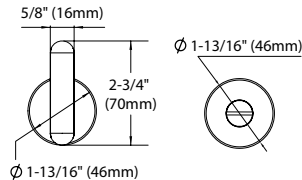

Product Illustration	Function	Item No.
	Mortise cylinder escutcheon	EC-R460COL
	Thumbturn on escutcheon	EC-R460TT07
	Thumbturn & Release	EC-R460TT07PVS

SR02

SR Small Rose.
TT04 Thumb-turn and release



SR Rose
T-Turn Side



SR Rose
Release Side

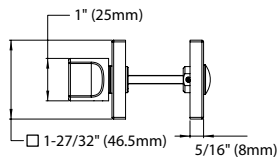

Product Illustration	Function	Item No.
	Mortise cylinder escutcheon	EC-S420COL
	Thumbturn on escutcheon	EC-S420TT02
	Thumbturn & Release	EC-S420TT02PVS

SR04

SR Small Rose.
TT04 Thumb-turn and release



SR Rose
T-Turn Side



SR Rose
Release Side

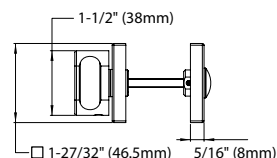

Product Illustration	Function	Item No.
	Mortise cylinder escutcheon	EC-S420COL
	Thumbturn on escutcheon	EC-S420TT02
	Thumbturn & Release	EC-S420TT02PVS

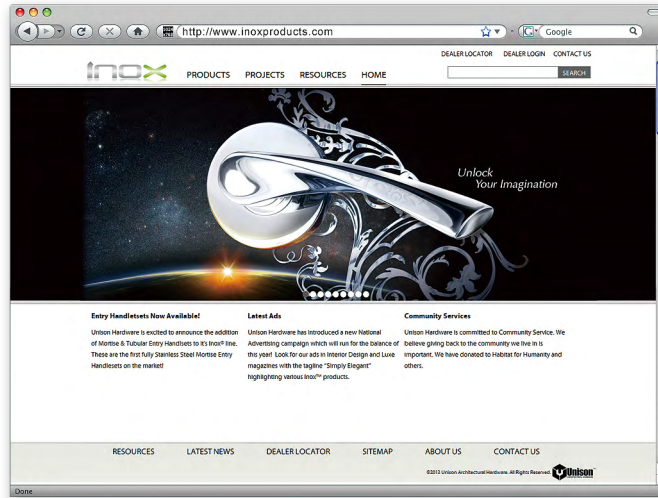

Please visit our website
<http://www.inoxproducts.com>
for more technical and new product information.



Unison Hardware, Inc.
6 Wayne Court, Sacramento, CA 95829, USA
Tel: +1.916.388.1888 Fax: +1.916.388.8322
Email: info@unisonhardware.com